

KTM POWERPARTS
INFORMATION

SIDE BAG CARRIER



93012912044

04.2017
3.213.714



KTM Sportmotorcycle GmbH
5230 Mattighofen, Austria
www.ktm.com



3 DEUTSCH

Wir freuen uns, dass Sie sich für dieses Produkt entschieden haben.

Unser hochwertiges Qualitätsprodukt ist rennerprobt und wurde speziell für sportliche Herausforderungen entwickelt. Eine korrekte Montage des Produktes ist unerlässlich, um ein Maximum an Sicherheit und Funktionalität gewährleisten zu können. Bitte befolgen Sie daher die Montageanleitung oder wenden Sie sich an Ihren autorisierten Fachhändler.

Für falsche Montage oder Verwendung dieses Produktes kann der (Quasi-)Hersteller bzw. Lieferant nicht zur Verantwortung gezogen werden.
Vielen Dank.

5 ENGLISH

Thank you for choosing this product.

Our high quality product has been tested under racing conditions and was developed specifically for use in sports activities. Correct installation of the product is essential to ensure that a maximum degree of safety and functionality is achieved. Therefore, please follow the installation instructions or contact your authorized dealer.

The (quasi) manufacturer or supplier cannot be held responsible for products that are incorrectly mounted or inappropriately used.
Thank you.

7 ITALIANO

Grazie per aver scelto questo prodotto.

Questo nostro prodotto di pregiata qualità è collaudato nelle competizioni ed è stato sviluppato specificamente per gare sportive. Il montaggio corretto del prodotto è fondamentale per garantirne la massima sicurezza e funzionalità. Rispetti quindi le istruzioni di montaggio o rivolgerti al proprio concessionario autorizzato.

Il produttore (detentore del marchio)/fornitore non può essere considerato responsabile per un montaggio o impiego errato del presente prodotto.
Vi ringraziamo per l'attenzione!

9 FRANÇAIS

Merci d'avoir porté votre choix sur ce produit.

Notre produit de haute qualité est éprouvé pour les compétitions et a été conçu spécialement pour un usage sportif. Un montage approprié du produit est indispensable pour garantir une sécurité et une fonctionnalité maximales du véhicule. C'est pourquoi nous vous invitons à suivre scrupuleusement le manuel de montage ou à vous adresser à votre revendeur agréé.

En cas de montage ou d'utilisation non conformes de ce produit, le (quasi) constructeur ou le fournisseur déclinent toute responsabilité.
Merci !

11 ESPAÑOL

Le agradecemos que se haya decidido por este producto.

Este producto de alta calidad está probado para la competición y se ha desarrollado específicamente para las exigencias de este deporte. Para poder garantizar los máximos niveles de seguridad y funcionalidad, es imprescindible que el producto se monte correctamente. Por este motivo, es muy importante que siga las instrucciones del manual de montaje o que se ponga en contacto con su concesionario autorizado.

El (cuasi) fabricante y el proveedor de este producto no se harán responsables del montaje y el uso incorrectos.
¡Muchas gracias!

Lieferumfang

- 1x Seitentaschenträger links ①
- 1x Seitentaschenträger rechts ②
- 2x Distanzbuchse hinten ③
- 2x Distanzbuchse vorn ④
- 4x Bundschraube M8x35 ⑤
- 4x Scheibe ⑥
- 2x Kofferaufnahme hinten ⑦
- 4x Kofferaufnahme ⑧
- 4x Senkschraube M6x20 ⑨
- 2x Zylinderschraube M6x20 ⑩
- 2x Zylinderschraube M6x12 ⑪
- 2x Sechskantmutter M6 ⑫
- 2x Verchlussstopfen ⑬

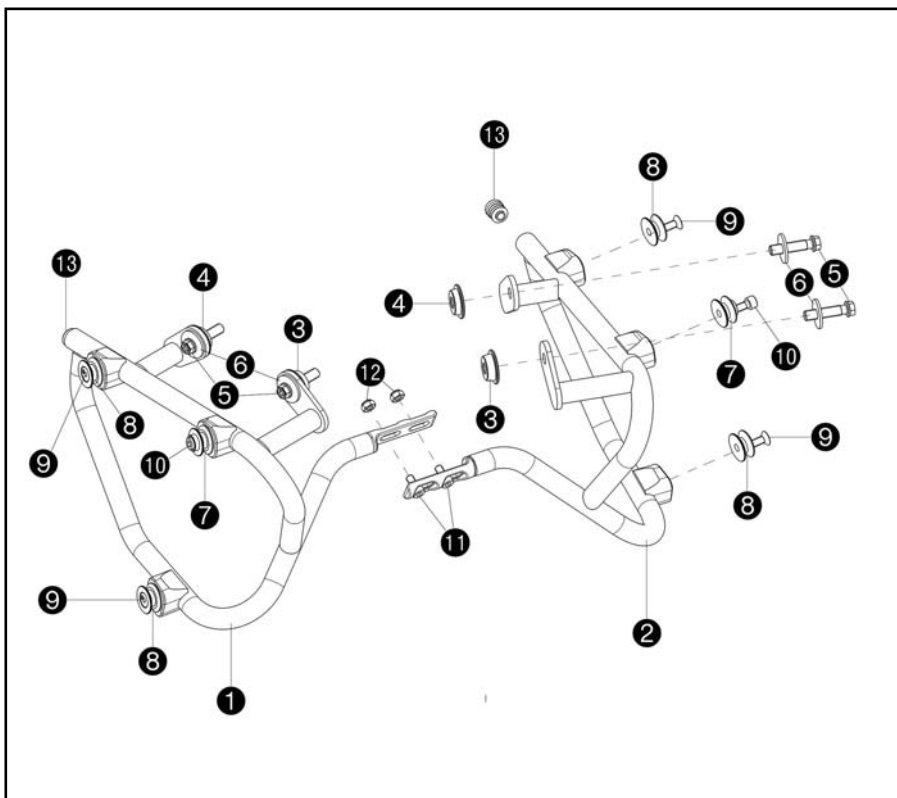

Vormontage

- Schrauben ⑭ beidseitig entfernen.

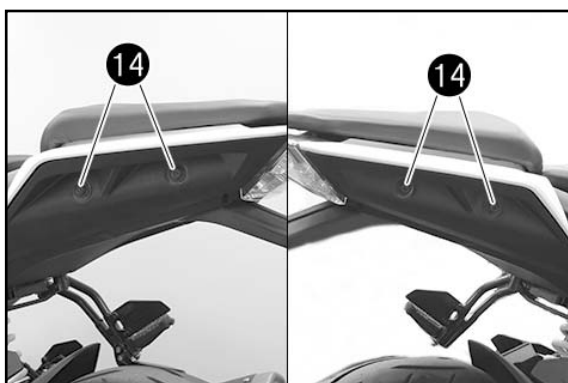

- Seitentaschenträger links ① (Lieferumfang) positionieren.
- Schraube ⑤ mit Scheibe ⑥ und Distanzbuchse vorn ④ und hinten ③ (alles Lieferumfang) montieren, aber noch nicht festziehen.

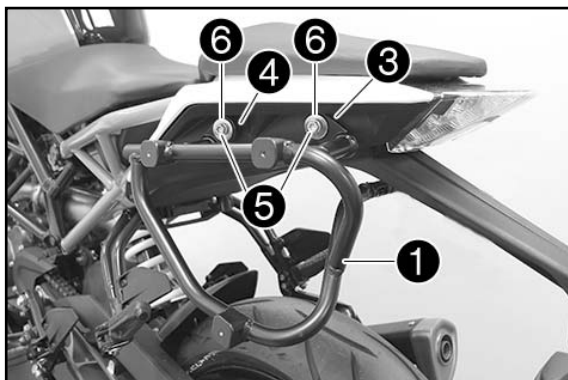

- Seitentaschenträger rechts ② (Lieferumfang) positionieren.
- Schraube ⑤ mit Scheibe ⑥ und Distanzbuchse vorn ④ und hinten ③ (alles Lieferumfang) montieren, aber noch nicht festziehen.

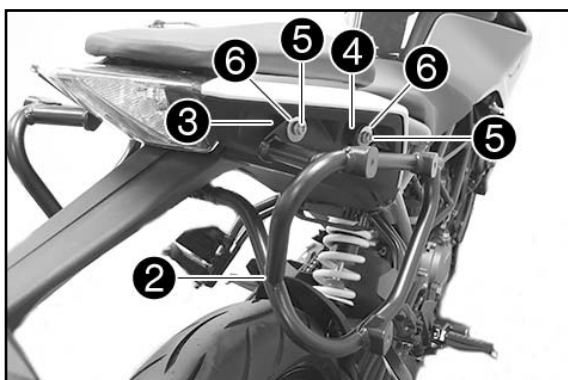

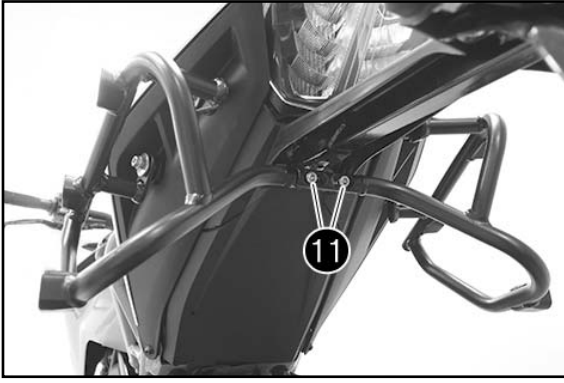

- Beide Seitentaschenträger positionieren.
- Schrauben ⑪ mit Muttern ⑫ (alles Lieferumfang) montieren und mit 12 Nm festziehen.
- Schrauben ⑤ beidseitig mit 20 Nm festziehen.

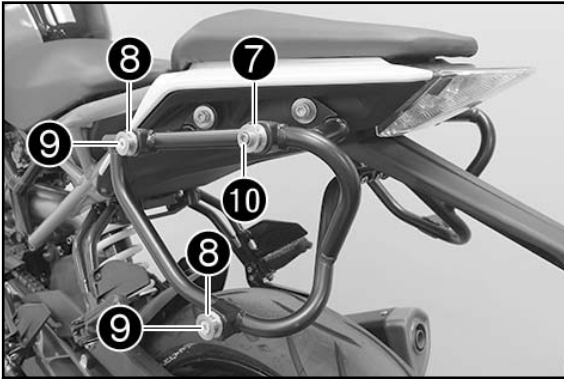

- Kofferaufnahmen ⑧ mit Schrauben ⑨ (alles Lieferumfang) beidseitig montieren und mit 10 Nm (Loctite 243) festziehen.
- Kofferaufnahme hinten ⑦ mit Schraube ⑩ (alles Lieferumfang) beidseitig montieren und mit 10 Nm (Loctite 243) festziehen.

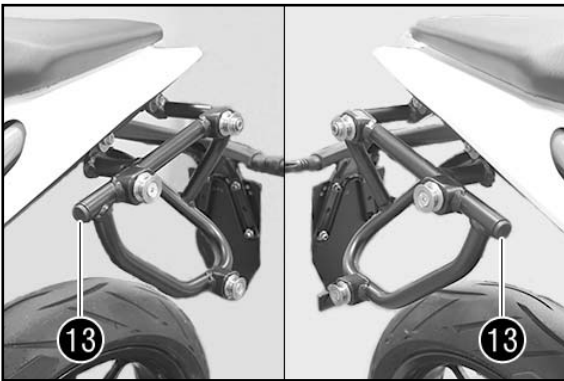
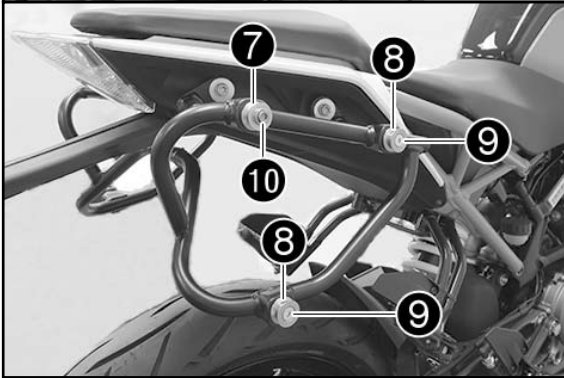

- Verschlussstopfen ⑬ (Lieferumfang) beidseitig montieren.



⚠ ACHTUNG

Aufgrund des geänderten Fahrverhaltens langsam an die zulässige Höchstgeschwindigkeit von 130 km/h herantasten!
 Achten Sie stets darauf, dass die Zuladung von 5 kg pro Seite keinesfalls überschritten wird!
 Achten Sie darauf, dass alle Zubehörteile und Gepäckstücke sorgfältig befestigt sind. Prüfen Sie dies regelmäßig nach!

Immer nur zwei Seitentaschen gleichzeitig benutzen und die Ladung gleichmäßig auf beide Seiten verteilen!
 Die Ladung gegen Verrutschen sichern!

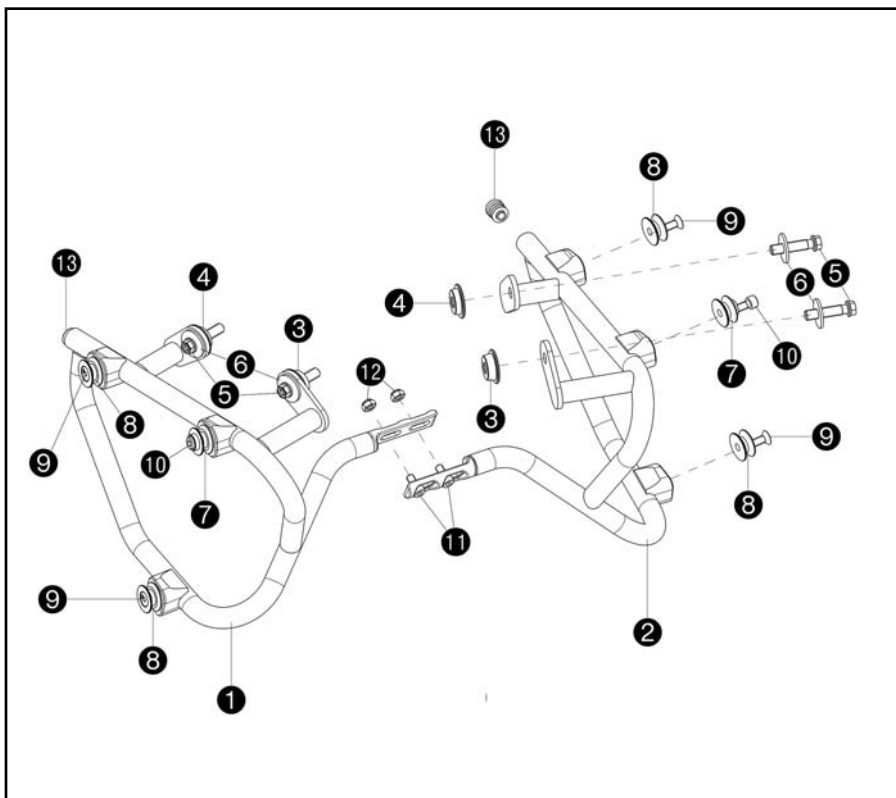

Scope of supply

- 1x side bag carrier, left ①
- 1x side bag carrier, right ②
- 2x spacer, rear ③
- 2x spacer, front ④
- 4x collar screw M8x35 ⑤
- 4x washer ⑥
- 2x case support, rear ⑦
- 4x case support ⑧
- 4x countersunk screw M6x20 ⑨
- 2x cap head screw M6x20 ⑩
- 2x cap head screw M6x12 ⑪
- 2x hexagon nut M6 ⑫
- 2x plug ⑬

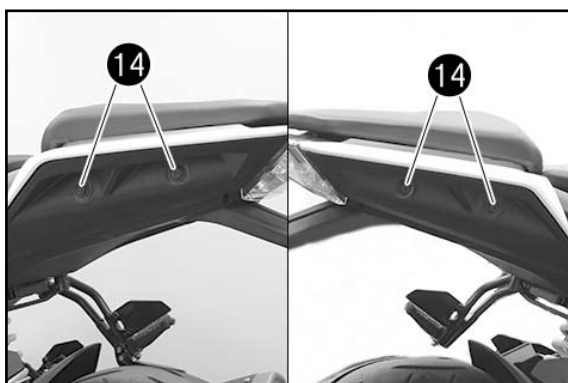

Preassembly

- Remove the screws ⑭ on both sides.

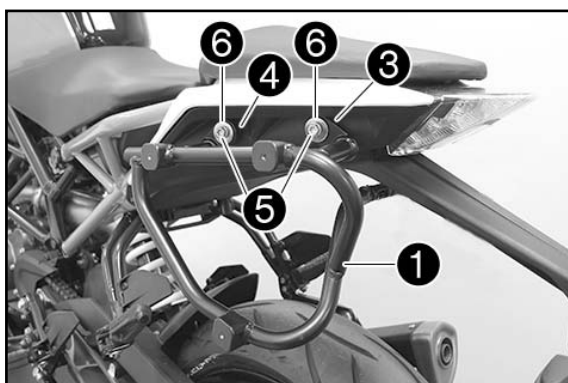

- Position left side bag carrier ① (included).
- Mount screw ⑤ with washer ⑥, front distance spacer ④ and rear distance spacer ③ (all included), but do not tighten yet.

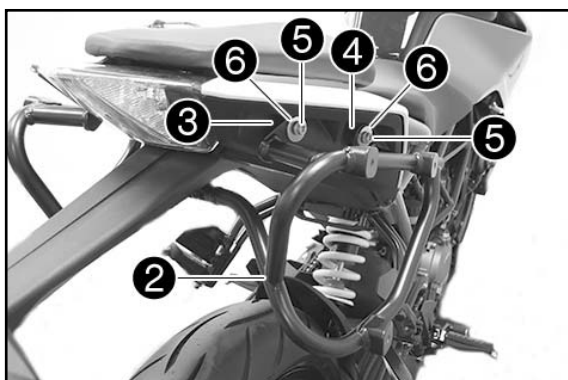

- Position right side bag carrier ② (included).
- Mount screw ⑤ with washer ⑥, front distance spacer ④ and rear distance spacer ③ (all included), but do not tighten yet.

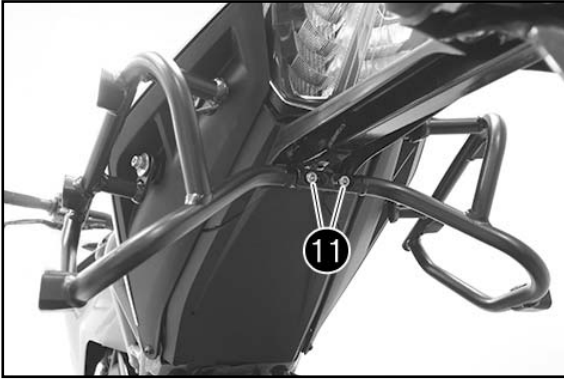

- Position both side bag carriers.
- Mount screws 11 with nuts 12 (all included) and tighten to 12 Nm.
- Tighten screws 5 to 20 Nm on both sides.

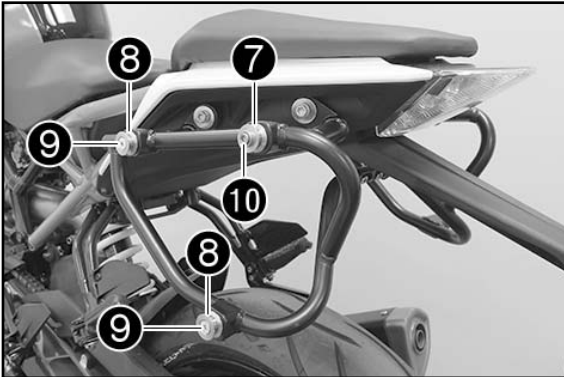

- Mount case supports 8 with screws 9 (all included) on both sides and tighten to 10 Nm (Loctite 243).
- Mount rear case support 7 with screws 10 (all included) on both sides and tighten to 10 Nm (Loctite 243).

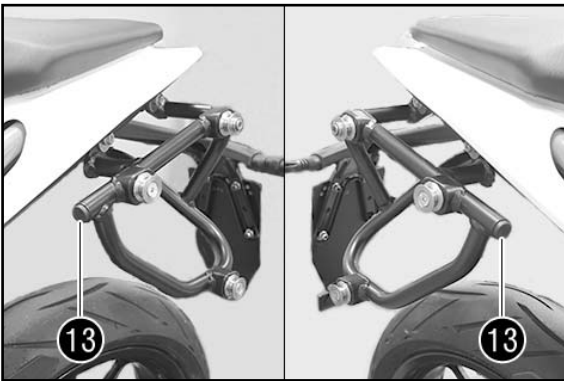
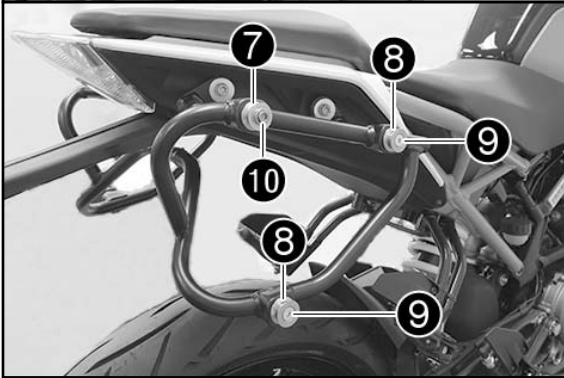

- Mount plugs 13 (included) on both sides.



⚠ WARNING
 Due to the changes in vehicle handling characteristics, accelerate gradually to the permitted maximum speed of 130 km/h!
 Ensure that the load never exceeds 5 kg per side!
 Make sure that all accessories and luggage items are securely fastened. Check this regularly!

Always use two side bags at the same time and distribute the load evenly between the two sides!
 Secure the load against slipping!

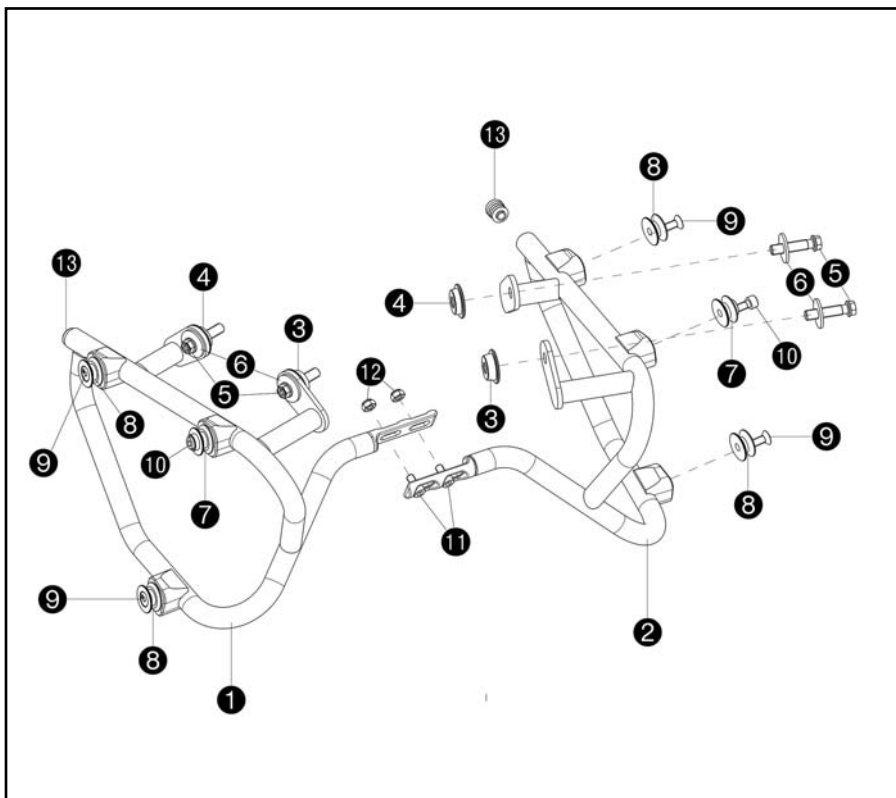

Materiale fornito

- 1 supporto borse laterali sinistro ①
- 1 supporto borse laterali destro ②
- 2 bussole distanziali posteriori ③
- 2 bussole distanziali anteriori ④
- 4 viti flangiate M8x35 ⑤
- 4 rondelle ⑥
- 2 alloggiamenti bagagli posteriori ⑦
- 4 alloggiamenti bagagli ⑧
- 4 viti a testa svasata M6x20 ⑨
- 2 viti a testa cilindrica M6x20 ⑩
- 2 viti a testa cilindrica M6x12 ⑪
- 2 dadi esagonali M6 ⑫
- 2 tappi ⑬

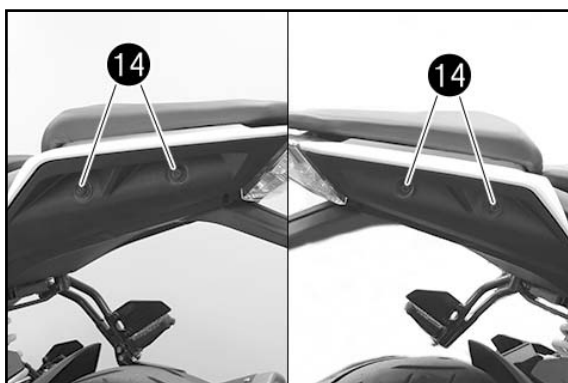

Premontaggio

- Rimuovere le viti ⑭ da entrambi i lati.

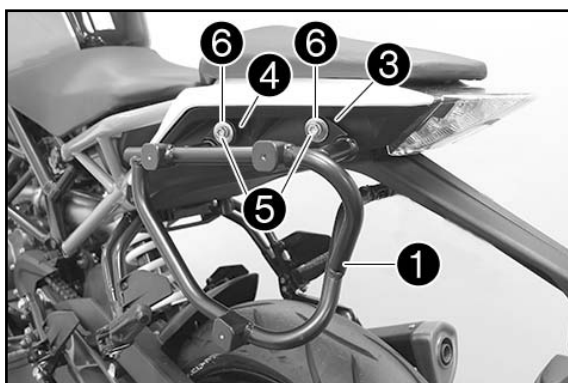

- Posizionare il supporto borse laterali sinistro ① (in dotazione).
- Montare la vite ⑤ con la rondella ⑥ e la bussola distanziale anteriore ④ e posteriore ③ (tutto in dotazione), senza serrare ancora.

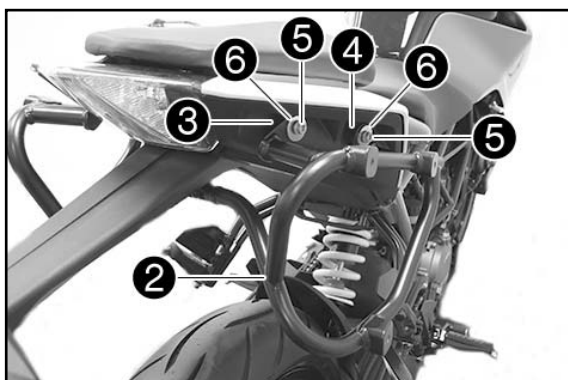

- Posizionare il supporto borse laterali destro ② (in dotazione).
- Montare la vite ⑤ con la rondella ⑥ e la bussola distanziale anteriore ④ e posteriore ③ (tutto in dotazione), senza serrare ancora.

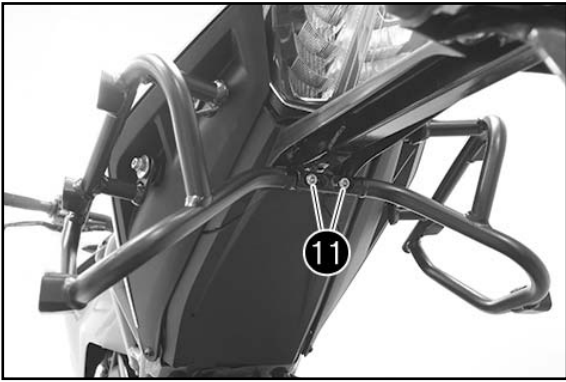

- Posizionare entrambi i supporti borse laterali.
- Montare le viti **11** con i dadi **12** (tutto in dotazione) e serrare a 12 Nm.
- Serrare le viti **5** su entrambi i lati a 20 Nm.

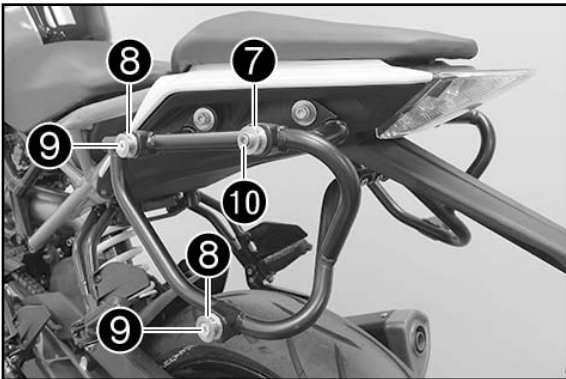

- Montare gli alloggiamenti bagagli **8** con le viti **9** (tutto in dotazione) su entrambi i lati e serrare a 10 Nm (Loctite 243).
- Montare l'alloggiamento bagagli posteriore **7** con la vite **10** (tutto in dotazione) su entrambi i lati e serrare a 10 Nm (Loctite 243).

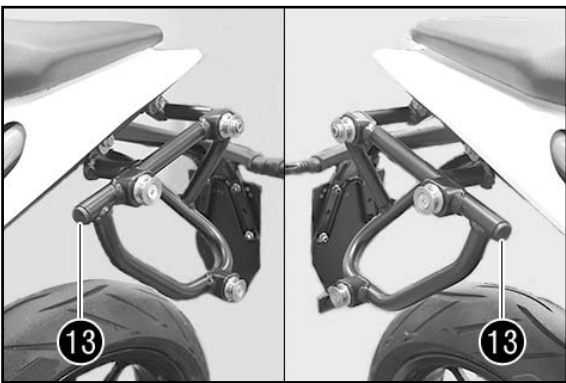
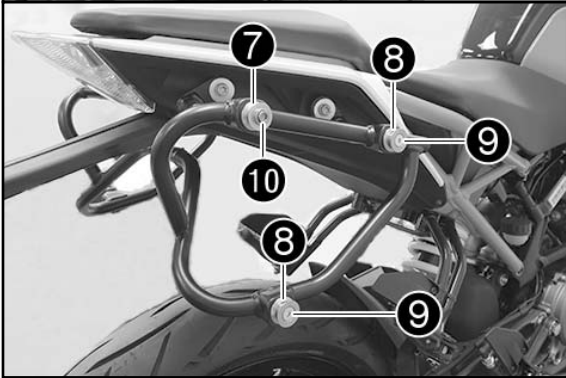

- Montare il tappo **13** (in dotazione) su entrambi i lati.



⚠ ATTENZIONE

Considerato il diverso comportamento in marcia, accelerare lentamente fino alla velocità massima consentita di 130 km/h! Attenzione a non superare in alcun caso il carico previsto di 5 kg per lato!

Non superare in nessun caso!

Verificare che tutti gli accessori e i portabagagli siano fissati accuratamente. Effettuare questa verifica regolarmente!

Non montare mai una sola borsa laterale ma sempre entrambe e distribuire uniformemente il carico su entrambi i lati! Assicurare il carico in modo che non si sposti!

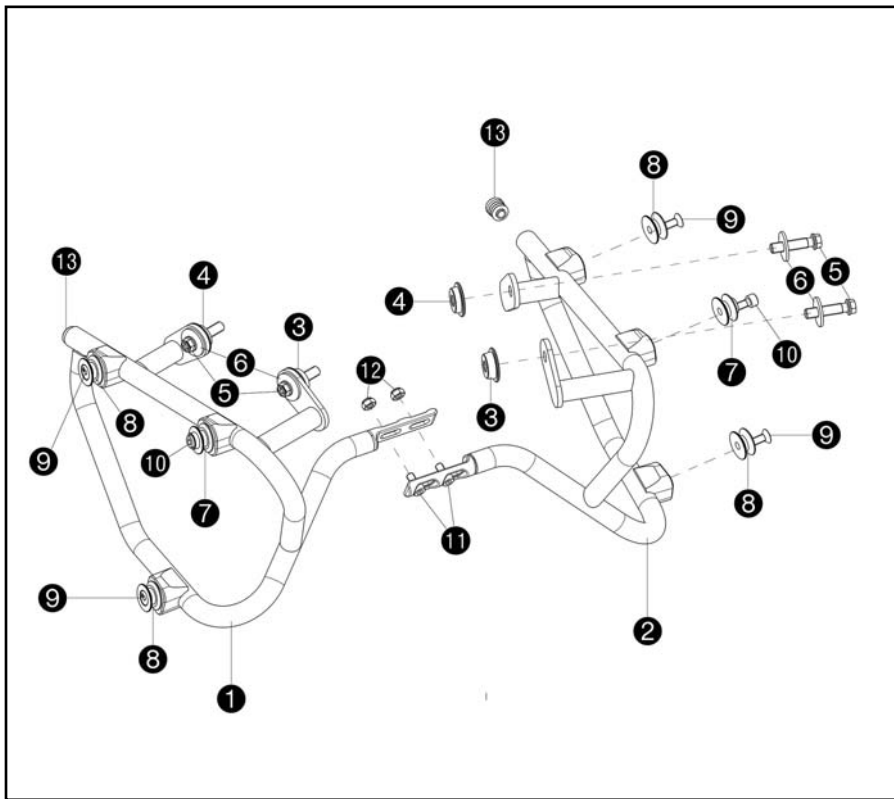

Contenu de la livraison

- 1x support de sac latéral gauche ①
- 1x support de sac latéral droit ②
- 2x douilles-entretoises arrière ③
- 2x douilles-entretoises avant ④
- 4x vis à épaulement M8x35 ⑤
- 4x rondelles ⑥
- 2x fixations de valise arrière ⑦
- 4x fixations de valise ⑧
- 4x vis noyées M6x20 ⑨
- 2x vis à tête cylindrique M6x20 ⑩
- 2x vis à tête cylindrique M6x12 ⑪
- 2x écrous M6 ⑫
- 2x bouchons ⑬

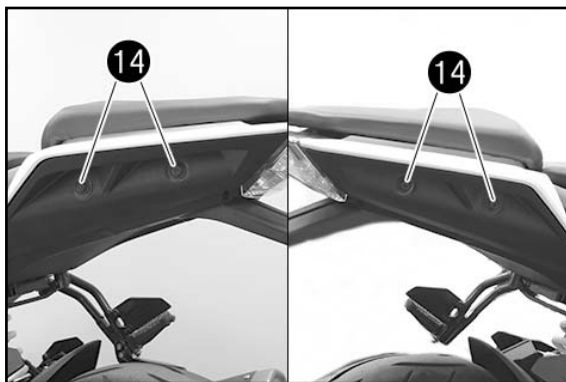

Prémontage

- Retirer les vis ⑭ des deux côtés.

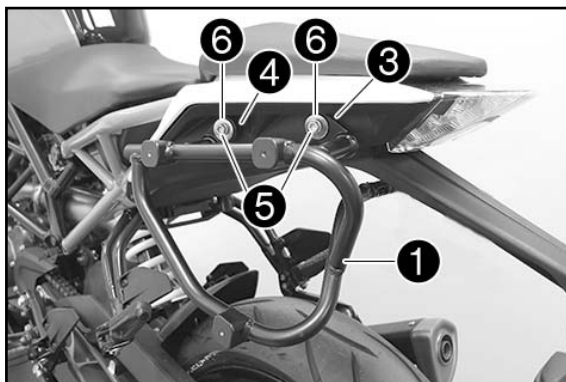

- Mettre en place le support de sac latéral gauche ① (fourni).
- Mettre en place la vis ⑤ avec la rondelle ⑥ et les douilles-entretoises avant ④ et arrière ③ (toutes fournies) sans serrer.

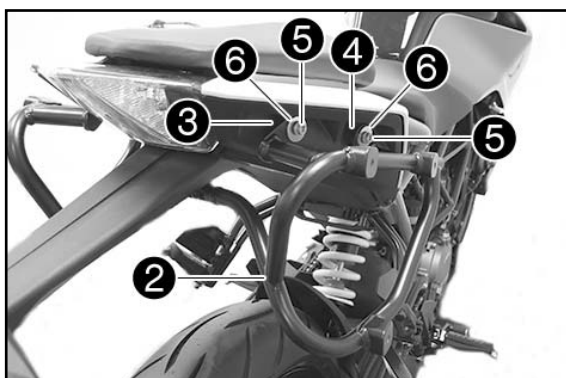

- Mettre en place le support de sac latéral droit ② (fourni).
- Mettre en place la vis ⑤ avec la rondelle ⑥ et les douilles-entretoises avant ④ et arrière ③ (toutes fournies) sans serrer.

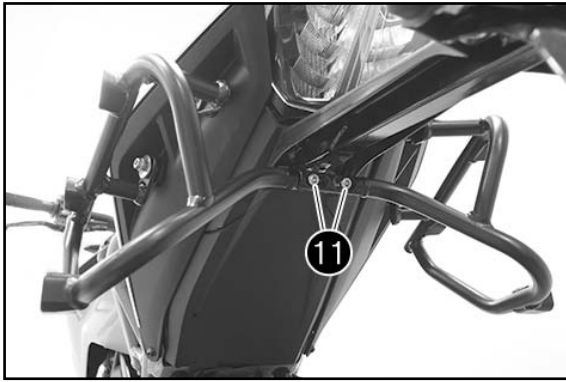

- Positionner les deux supports de sac latéral.
- Mettre en place les vis 11 et les écrous 12 (tous fournis) et les serrer au couple de 12 Nm.
- Serrer les vis 5 de chaque côté à 20 Nm.

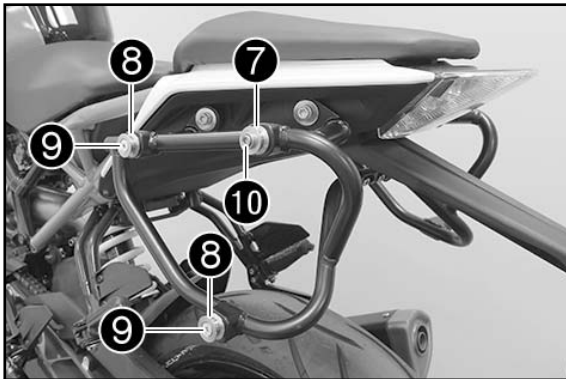

- Mettre en place les fixations de valise 8 de chaque côté avec les vis 9 (toutes fournies) et les serrer à 10 Nm (Loctite 243).
- Mettre en place la fixation de valise arrière 7 avec la vis 10 (toutes fournies) et les serrer à 10 Nm (Loctite 243).

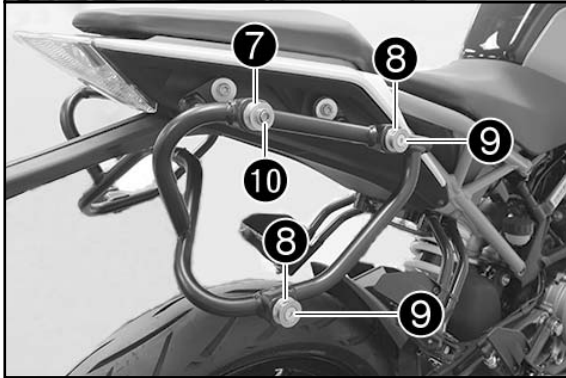

- Mettre en place les bouchons 13 de chaque côté (fournis).

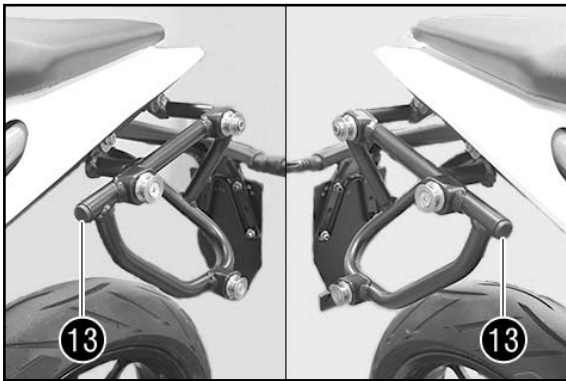

⚠ ATTENTION

En raison de la tenue de route altérée, accélérer lentement jusqu'à la vitesse maximale de 130 km/h !
 Veiller à ne pas dépasser de chaque côté une charge utile de 5 kg !
 Veiller à ce que tous les bagages et accessoires soient correctement fixés. Effectuez des contrôles réguliers !

Ne pas utiliser plus de deux sacs latéraux et répartir la charge uniformément des deux côtés !
 Arrimer la charge pour l'empêcher de glisser !

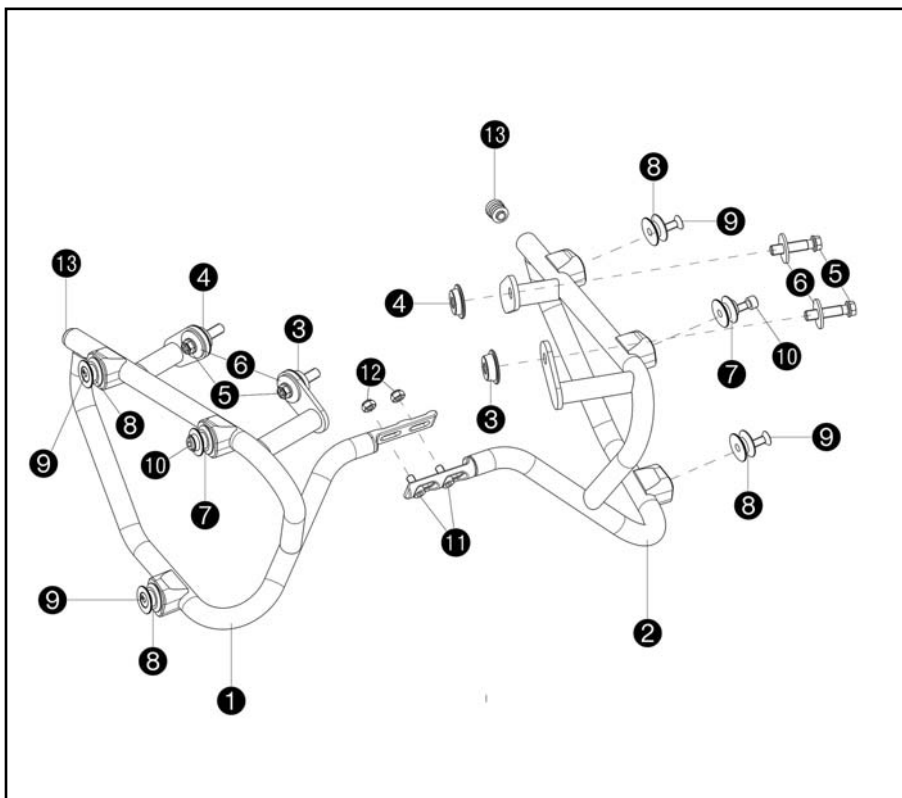

Volumen de suministro

- 1x fijación para bolsas laterales izquierda ❶
- 1x fijación para bolsas laterales derecha ❷
- 2x casquillos distanciadores traseros ❸
- 2x casquillos distanciadores delanteros ❹
- 4x tornillos de collarín M8x35 ❺
- 4x arandelas ❻
- 2x alojamientos traseros para maleta ❼
- 4x alojamientos para maletas ❸
- 4x tornillos de cabeza avellanada M6x20 ❾
- 2x tornillos cilíndricos M6x20 ❿
- 2x tornillos cilíndricos M6x12 ⓫
- 2x tuercas hexagonales M6 ⓬
- 2x tapones ⓭

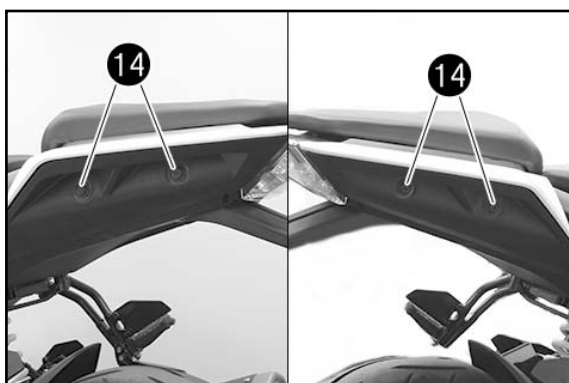

Tareas previas de montaje

- Retirar los tornillos ❶❷ a ambos lados.

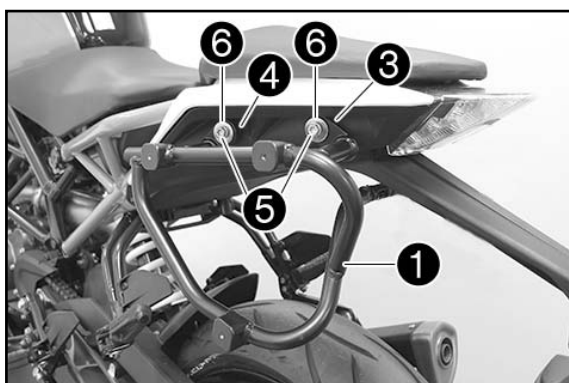

- Posicionar la fijación para bolsas laterales izquierda ❶ (volumen de suministro).
- Montar el tornillo ❺ con la arandela ❻ y el casquillo distanciador delantero ❹ y trasero ❸ (todo incluido en el volumen de suministro), pero no apretarlo todavía.

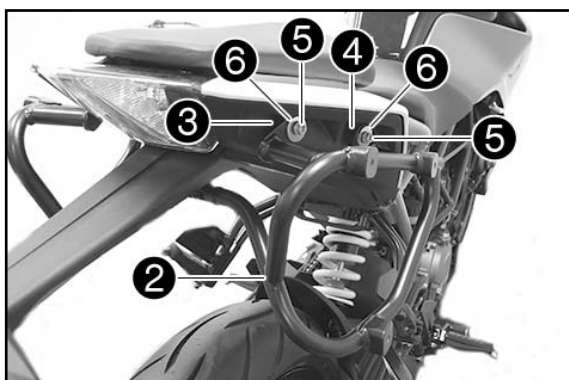

- Posicionar la fijación para bolsas laterales derecha ❷ (volumen de suministro).
- Montar el tornillo ❺ con la arandela ❻ y el casquillo distanciador delantero ❹ y trasero ❸ (todo incluido en el volumen de suministro), pero no apretarlo todavía.

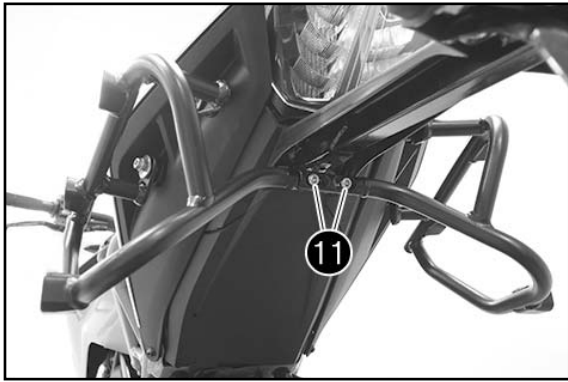

- Posicionar la fijación para bolsas laterales.
- Montar y apretar a 12 Nm los tornillos 11 con las tuercas 12 (todo incluido en el volumen de suministro).
- Apretar los tornillos 5 a 20 Nm en ambos lados.

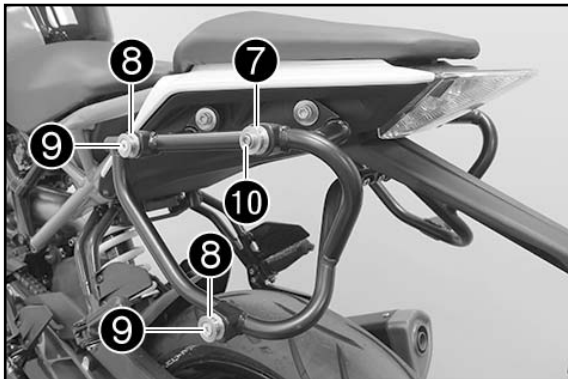

- Montar los alojamientos para maletas 8 con los tornillos 9 (todo incluido en el volumen de suministro) en ambos lados y apretarlos a 10 Nm (Loctite 243).
- Montar los alojamientos traseros para maletas 7 con el tornillo 10 (todo incluido en el volumen de suministro) en ambos lados y apretarlos a 10 Nm (Loctite 243).

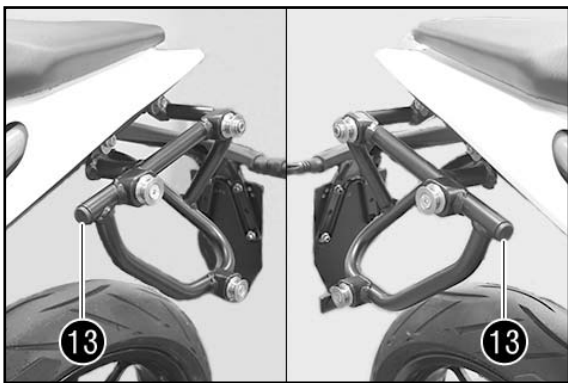
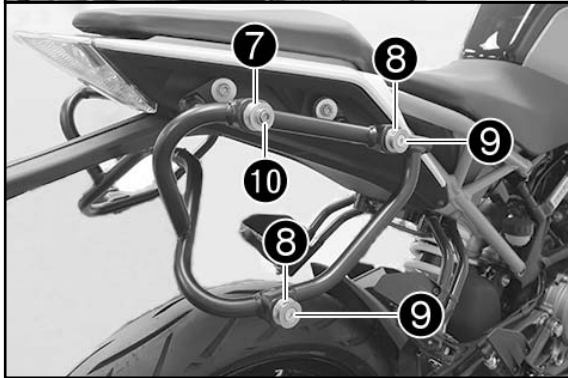

- Montar el tapón 13 (volumen de suministro) en ambos lados.



⚠ ATENCION

¡Debido a los cambios en el comportamiento del vehículo, ir aumentando lentamente la velocidad hasta la velocidad máxima permitida de 130 km/h!

Tener siempre en cuenta que la carga no debe sobrepasar los 5 kg en cada lado bajo ningún concepto!

Prestar atención a que todos los accesorios y piezas de equipaje estén sujetos adecuadamente. Comprobarlo regularmente.

¡Utilizar siempre a la vez las dos bolsas laterales y repartir la carga equitativamente entre los dos lados!

¡Asegurar la carga para que no pueda desplazarse!